

**Agilent 1260 Infinity  
LC & LC/MS Purification Systems**

**Purify your way**



**1260**



**Agilent Technologies**

## PURIFY YOUR WAY WITH MAXIMUM PURITY AND RECOVERY

Agilent 1260 Infinity LC and LC/MS Purification Systems offer flexible and easy-to-use solutions for purification of microgram to gram quantities of samples – with maximum levels of recovery and purity. Choose from a wide range of separation and detection modules to tailor a system that meets your needs. Raise your laboratory's productivity with workflow-based software for automated transfer of methodologies from analytical to preparative scale.

### Modular design for maximum flexibility

The modularity of the Agilent 1260 Infinity Purification Systems offers you outstanding flexibility to match the application challenges and bench-space restrictions of your laboratory.

- Flexible positioning and stacking of modules to achieve shortest possible fluidic connections
- Easy adaption or upgrade to meet future requirements
- Flow rates from 100  $\mu$ L/min to 100 mL/min for analysis and purification from UHPLC to preparative LC/MS
- Multiple detection options, including UV, MS, evaporative light scattering, fluorescence or refractive index
- Extensive choice of fraction containers such as test tubes, well plates, HPLC vials or Eppendorf tubes

### Intuitive software for ease of use

Agilent OpenLAB Chromatography Data System (CDS) software is a powerful yet easy-to-use application that puts you in complete control of your analytical and preparative-scale purification workflows.

- Triggers fraction collection based on any combination of time, peak or mass from your choice of detectors
- Calibrates delay volume automatically for optimum fraction collection
- Previews fractions for precise setting of peak slope and threshold triggers
- Raises your laboratory's productivity with a workflow-based add-on for automated scale-up



PAGE 4

Agilent 1260 Infinity Analytical-scale Purification System – for ultimate flexibility and versatility in purification.



PAGE 5

Agilent 1260 Infinity Preparative-scale Purification System – for purification of milligram to gram quantities of material.



PAGE 6

Agilent 1260 Infinity Automated Purification System – for highest productivity through automated method transfer from analytical to preparative-scale purification.

## Workflow-based software for automated scale-up

Agilent Automated Purification Software is an easy-to-install add-on for OpenLAB CDS software and facilitates automated transfer of purification methodologies from analytical to preparative scale. Algorithms calculate focused gradients on-the-fly for each target compound, ensuring highest purity of fractions collected during preparative-scale purification runs.

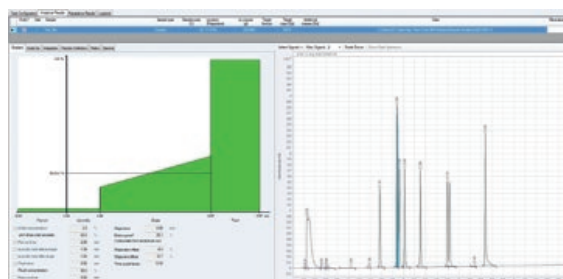

On-the-fly generation of focused gradients to ensure highest purity of collected fractions.

## Automated delay volume calibration for optimum fraction collection

Agilent fraction collectors are fitted with a delay sensor, which automatically determines the delay volume between the purification system's detector and the fraction collector. This calibration of delay volume ensures optimum collection of your target compounds regardless of the system configuration or flow rates, and eliminates the need to collect extra volumes.

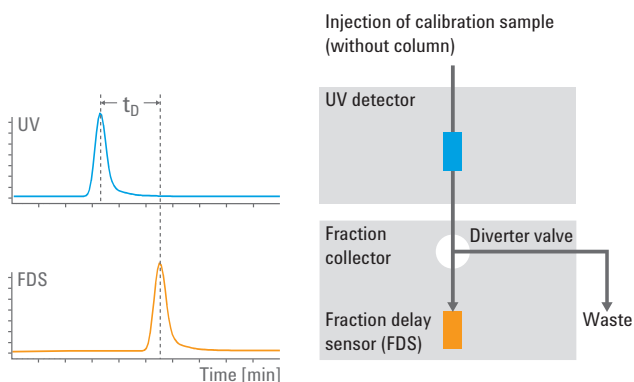

Automated delay volume calibration provides for optimum recovery of target compounds.

## Fraction preview for precise setting of triggering parameters

A fraction preview tool in Agilent OpenLAB CDS allows you to optimize collection parameters interactively. Slope and threshold triggers are set easily by sliding the trigger lines across the chromatogram. The selected triggers parameters become part of the purification method for subsequent runs.

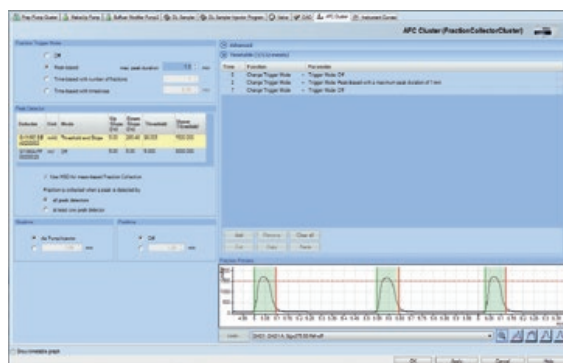

Multiple collection modes are possible and the fraction preview in Agilent OpenLAB CDS makes it easy to determine the correct trigger parameters.

## ACHIEVE HIGHEST PURITY AND RECOVERY THROUGH ONE SIMPLE YET EASY-TO-USE SOFTWARE PLATFORM

The Agilent 1260 Infinity Analytical-scale Purification System is an indispensable tool in your purification workflow – on one system with one software you can perform both analytical UHPLC and preparative LC.

### Analyze and purify on one software platform

A single, intuitive software is all you need to run complex analytical UHPLC separations and then scale-up to LC purification. The Agilent OpenLAB CDS ChemStation Edition software includes a graphical fraction preview tool that helps you to visualize the optimization of all relevant fraction trigger parameters based on previously acquired data.

### Maximize purity and compound recovery

The Agilent 1260 Infinity Analytical-scale Purification System handles flow rates from 100  $\mu\text{L}/\text{min}$  to 10  $\text{mL}/\text{min}$  at pressures up to 600 bar, making it the system of choice for compound purification in the nanogram to low milligram range on columns with internal diameters between 2.1 and 9.4 mm.

Agilent's fraction delay sensor technology determines fraction delay volumes automatically and ensures that fractions are collected just-in-time without the need to collect extra volume to be on the safe side.

Multiple detection options are available with straightforward upgrade from a basic UV-based system to advanced mass-based detection.

Time, peak and mass-based fraction collection – or any combination of these – are available and can be triggered by the detector of your choice. Intelligent real time data processing for instantaneous and precise fraction collection is guaranteed through the control area network (CAN).



With a completely metal-free flow path, the Agilent 1260 Infinity Bio-inert LC System with fraction collector is the ideal solution for protein purification.



Based on Agilent's industry-leading liquid chromatography platform, the Agilent 1260 Infinity Analytical-scale Purification Systems can be tailored to your sample and detection requirements and are supported by a multitude of application examples.

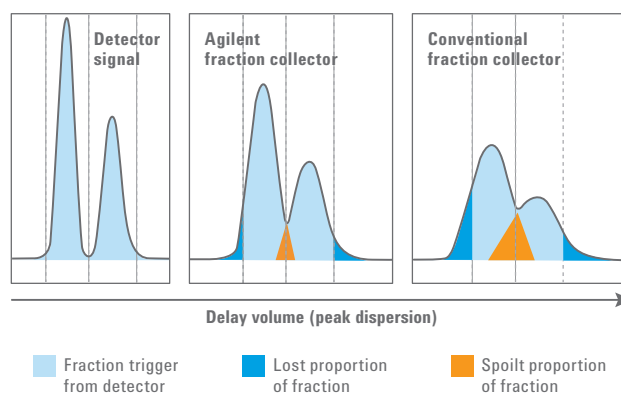

The Agilent 1260 Infinity Fraction Collectors are designed for lowest delay volumes to avoid peak dispersion and carry-over between fractions, assuring highest recovery and purity for your fractions.

## MAXIMIZE YOUR PURIFICATION FLEXIBILITY WITH RUGGED ANALYTICAL-TO-PREP SCALE-UP

The Agilent 1260 Infinity Preparative-scale Purification System offers you ultimate flexibility – use it as a workhorse for automated, high-throughput applications, or as a method scale-up solution for optimizing resolution and recovery.

### Purify milligrams to grams of material

The Agilent 1260 Infinity Preparative-scale Purification System is ideal for purification when you have milligrams to grams of starting material. The system delivers high flow rates up to 100 mL/min and is a perfect match for columns with internal diameters from 9.4 to 30 mm.

### Benefit from ultimate flexibility

The modular design of the Agilent 1260 Infinity Preparative-scale Purification System offers you outstanding flexibility in terms of application and bench space. One of the major advantages of this modularity is the ability to achieve shortest possible fluidic connections. Using optimized tubing diameters for different flow rates results in smallest delay volumes, minimal peak dispersion and lowest overlap between fractions. And, if your purification needs change, you can easily adapt or upgrade the system to meet the new workflow, detection or throughput requirements.

### Robust scale-up from analytical to prep

As the market and technology leader in LC instrumentation Agilent clearly differentiates itself in terms of product quality, robustness and ease of use. The Agilent fraction delay sensor technology guarantees just-in-time peak collection regardless of your instrument configuration. Temperature control of autosamplers and fraction collectors prevents deterioration of labile compounds – even during prolonged storage.



The Agilent 1260 Infinity Preparative-scale Purification System can be configured with multiple fraction collectors for high-throughput applications. Detection capabilities can be extended easily, for example, with an MS detector.

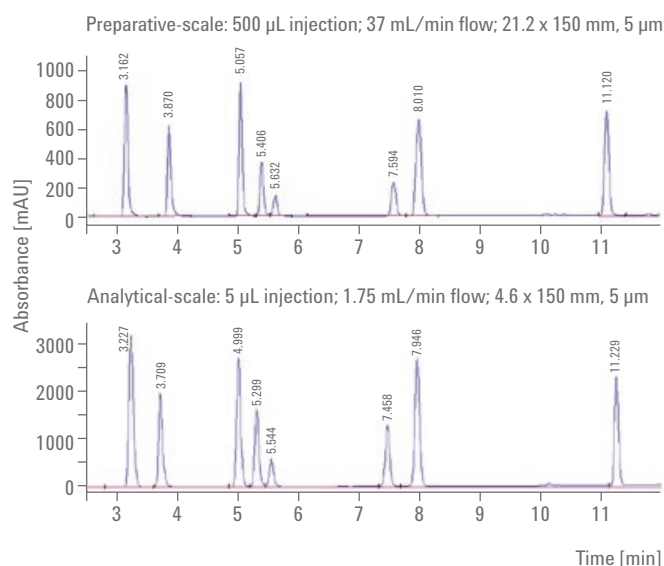

Linear scale-up from analytical to prep with generic gradient.

## PURIFY YOUR WAY WITH A WORKFLOW-BASED SOLUTION FOR AUTOMATED ANALYTICAL-TO-PREPARATIVE SCALE-UP

The Agilent 1260 Infinity Automated Purification System is a scalable, workflow-based solution that combines proven and robust 1200 Infinity Series modules with new software for automated scale-up from analytical method scouting to optimized purification with maximum purity and recovery.

### Streamline your purification workflow

With combined or dedicated analytical and preparative-scale systems configured to meet the throughput demands of your laboratory, Agilent's new purification software automates the transfer of data between process steps, streamlining your workflow for highest productivity.

- Import of sample data in common formats
- Setup of sequence tables for analytical method scouting in walk-up mode
- Confirmation of target compounds in crude products
- Calculation of focused gradient profiles for scale-up from analytical to preparative column dimensions
- Review of collected fraction purity by UV and MS spectral data
- Selection of fractions for pooling
- Setup of sequence tables for reanalysis of fractions

### Tailor a solution to match your workflow

The modularity of the Agilent 1260 Infinity Purification Systems offers you outstanding flexibility to match the application challenges, throughput demands and bench-space restrictions of your laboratory.

### Easy for occasional users – easy for experts

The Agilent automated purification software is easy to use, regardless of the level of functionality your users need to complete their tasks.

The EasyPrep mode provides everything required for occasional purification tasks. Within a few clicks the user can set the desired combination of analytical and preparative columns, upload and process the analytical results, launch the purification run, and review the purification results.

Full access to the entire functionality is available through the expert mode, which also provides for configuration of preset methodologies for occasional users.



A typical purification workflow that can be automated by deploying the new Agilent Automated Purification Software with a combined analytical and preparative system based on UV or MS detection.

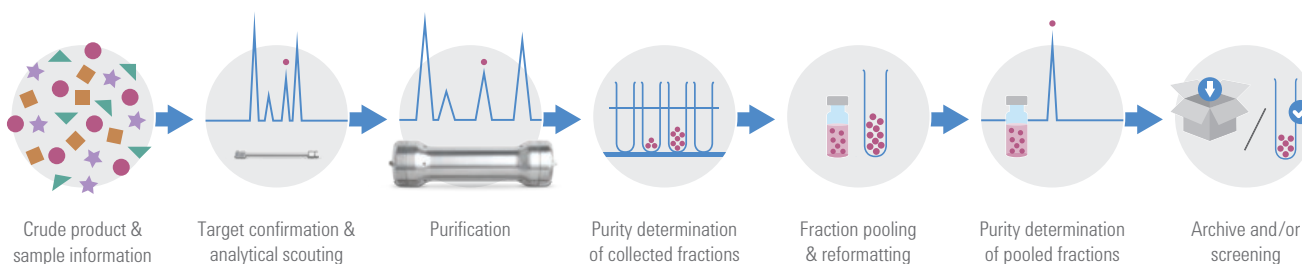



## Automated calculation of focused gradient profiles for highest purity and recovery

When you have confirmed the identity of your target compound, the automated purification software uses special algorithms to calculate a focused gradient profile for the subsequent preparative-scale purification run. This ensures highest purity and recovery of the collected fractions while optimizing resolution and run time for minimum solvent consumption. A focused gradient profile can be calculated for each target compound of interest, optimizing the overall efficiency of your laboratory operation.

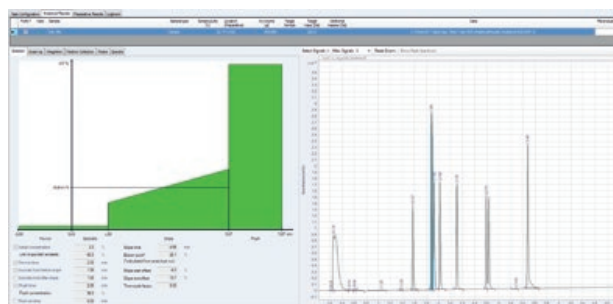

A focused gradient profile ensures highest purity and recovery.

## Purification results are available at-a-glance for identification of fractions for reanalysis

The fraction results browser allows you to monitor the collected fractions from the purification run. At a glance you can see all chromatographic results, including UV and mass spectral data from each collected fraction. This helps you to identify which fractions need to be reanalyzed to determine the purity of the fraction. Just a single click is required to add the sample to a sequence for reanalysis.

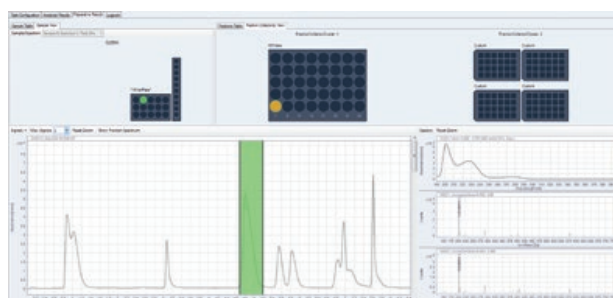

An interactive browser lets you see all your results – at a glance.

## One-click selection of samples for fraction pooling by automatic liquid handlers

In the same way that new sample lists for reanalysis can be generated, the automated purification software allows you to select samples for pooling and then export the lists to automatic liquid handlers for processing.

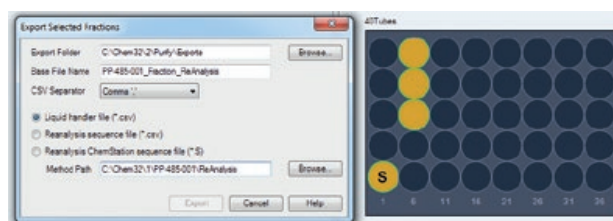

Your selected fractions can be pooled by an automatic liquid handler.

## TAILOR YOUR SYSTEM TO MEET YOUR NEEDS

### Solvent delivery



**Isocratic pump**

Flow range 0.001–10 mL/min



**Quaternary pump**

Flow range 0.001–10 mL/min



**Binary pump**

Flow range 0.001–5 mL/min



**Preparative pump**

Flow range 0.001–100 mL/min

### Sample injection



**Standard autosampler**

Injection volumes 0.1–100  $\mu$ L



**Preparative autosampler**

Injection volumes 0.1–5000  $\mu$ L



**Dual-loop autosampler**

Injection volumes up to 10 mL

### Column management



**Column compartment**

10 degrees below ambient to 80°C

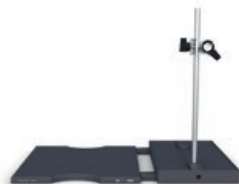

**Column/valves organizer**

### Fraction collection



**Analytical-scale fraction collector**

Flow rates up to 10 mL/min



**Preparative-scale fraction collector**

Flow rates up to 100 mL/min

### Compound detection



**UV-absorbance detectors**

Variable wavelength, multiple wavelength or diode array



**Evaporative light scattering detector**



**6100 Series Single Quadrupole LC/MS**



## EXPAND YOUR PURIFICATION POSSIBILITIES

### Switching valves for even more flexibility

Agilent Quick-Change valves are a key element in our purification solutions, providing for flow switching between analytical and preparative systems, or between stacked fraction collectors. Capable of handling the high flow rates typically used in preparative liquid chromatography, these valves allow you to automate a wide variety of applications such as column selection or regeneration.

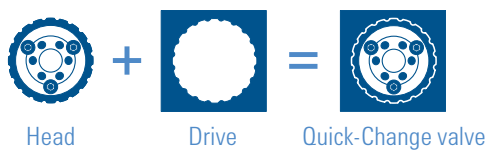

The valves' unique design with separate valve heads and drives gives you the flexibility to choose combinations that match your laboratory's individual application requirements.

### Column selection

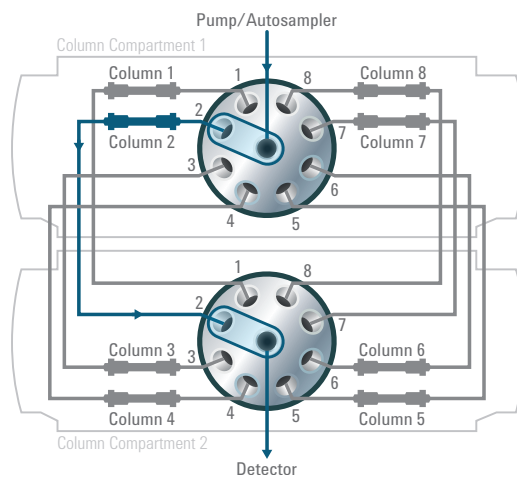

Select from up to eight columns using two 8-position/9-port valves housed in two column compartments.

### Analytical-to-preparative switching

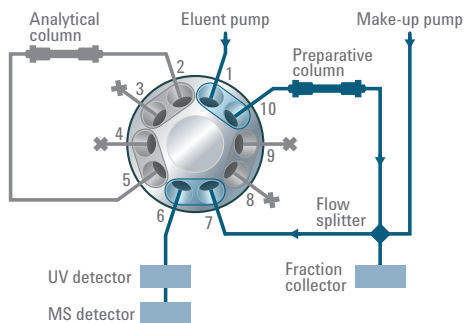

Switch between method scouting and purification runs on a combined system configured for both analytical and preparative work.

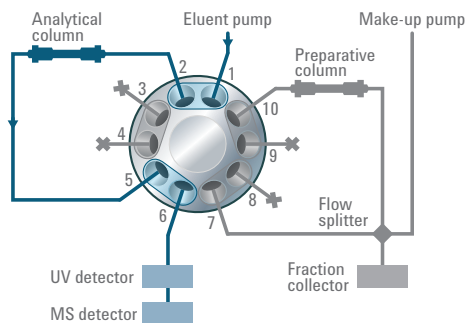

### Automated column regeneration

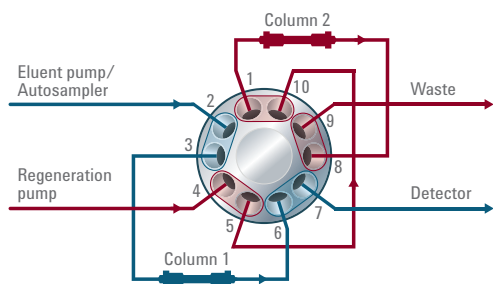

While the analysis is running on column 1, column 2 is regenerated using the flow from a second pump.

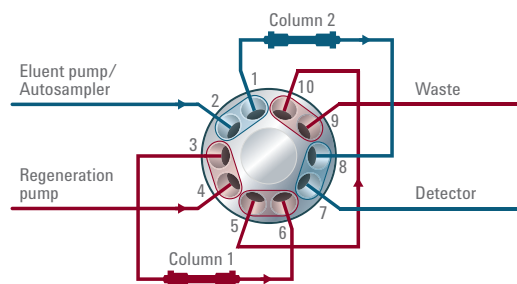

After the analysis on column 1, the flow switches to column 2 for analysis while column 1 is regenerated.

## HIGHEST SAMPLE LOADING FOR RELIABLE PURIFICATION OF LARGE AMOUNTS AT LOWER COST

Whether you are scaling up a routine analytical method, or maintaining precise separations throughout every phase of production, our wide array of preparative and process columns and bulk media are designed for high loadability in a range of particle sizes and phases.

### Semiprep and Prep Columns

- Agilent Prep LC columns are a cost-effective solution for high loadability to purify milligram to gram quantities with C18 and unbonded silica
- Agilent ZORBAX Prep HT columns are for rapid scale-up within the ZORBAX family, with optimized resolution and loadability under any conditions, up to 2,000 mg
- Agilent Pursuit and Pursuit XRs Prep columns offer high loadability with a high surface area, with C18, C8, Diphenyl, and Si, plus fluorinated PFP and PAH polymeric for shape selectivity
- Agilent PLRP-S Prep columns span µg/mg discovery to multiple-gram cGMP applications with a polymeric material that provides excellent chemical stability, up to 1 M NaOH, for column sanitation and regeneration
- Agilent PL-SAX and PL-SCX Prep columns have strong ion-exchange functionalities covalently linked to a chemically stable polymer for high-capacity purifications, or large biomolecules with high-speed, high-resolution purifications
- Bulk materials are available for most phases and can be ordered through Agilent's Custom Ordering Process:  
[www.agilent.com/chem/customlc](http://www.agilent.com/chem/customlc)



Agilent ZORBAX Prep HT columns enable rapid scale-up within the ZORBAX family from analytical to preparative applications.

### Load & Lock Columns for Flexibility

- Available as 50 cm length column tubes with 1, 2 or 3 inch id
- Easy-to-use packing station allows you to pack any commercially-available media using dynamic axial compression (DAC) or static axial compression (SAC)
- Unique fluid and sample distribution technology for increased sample loading, minimized peak broadening and reduced back pressure

Proprietary fluid and sample distribution plates at the inlet and outlet of the column diffuse the sample more efficiently across the full bed surface, providing exceptional separation efficiency, and a 20 % increase in load minimizes back pressure and peak broadening.



A complete range of Agilent Load & Lock columns delivers versatile solutions for high performance, high throughput and high yield preparative and process purifications.

## PURIFY YOUR WAY WITH PURELY BETTER SOLUTIONS FOR COMPOUND ISOLATION

Agilent offers the most comprehensive portfolio of flexible and reliable solutions for purification by liquid chromatography. No matter what scale you are working at, Agilent has high-performance instrumentation, columns, software and services that ensure highest purity and maximum recovery.

	Analytical		Semi-preparative		Preparative		Pilot
Productivity Range	Micrograms	Milligrams		Grams			
<b>Agilent 1260 Infinity Analytical Scale</b>	0.1–10 mL/min						
<b>Agilent 1260 Infinity Preparative Scale*</b>	1–100 mL/min						
<b>Agilent 218</b>	1–25 mL/min		5–100 mL/min		20–200 mL/min		
<b>Agilent SD-1</b>	1–200 mL/min						500 mL/min
<b>Column Inside Diameter</b>	4.6 mm	½ inch (10 mm)	1 inch (21–25 mm)	(30 mm)	2 inch (50 mm)	3 inch (75 mm)	
<b>Flow Rate (mL/min)</b>	1	4.7	20–25	42	118	265	

 Flow range extensions made possible by exchangeable pump heads

\*Optional software available for automated analytical-to-preparative scale-up

### Download brochures



Agilent 218 Purification Systems  
[www.agilent.com/chem/218bro](http://www.agilent.com/chem/218bro)



Agilent SD-1 Purification Systems  
[www.agilent.com/chem/SD1bro](http://www.agilent.com/chem/SD1bro)



Agilent Load & Lock Columns  
[www.agilent.com/chem/LLbro](http://www.agilent.com/chem/LLbro)

Learn more

**[www.agilent.com/chem/purification](http://www.agilent.com/chem/purification)**

Find an Agilent customer center

**[www.agilent.com/chem/contactus](http://www.agilent.com/chem/contactus)**

USA and Canada

**1-800-227-9770**

**[agilent\\_inquiries@agilent.com](mailto:agilent_inquiries@agilent.com)**

Europe

**[info\\_agilent@agilent.com](mailto:info_agilent@agilent.com)**

Asia Pacific

**[inquiry\\_lsca@agilent.com](mailto:inquiry_lsca@agilent.com)**

This information is subject to change without notice.

© Agilent Technologies, Inc. 2010-2014

Published in the USA, February 1, 2014

5991-3215EN



**Agilent Technologies**